

Delivery and Installation Instructions - 'The Curve' Garden Shelter

Thank you for choosing this Jacksons product. Our high quality fencing and garden products will last for years and give you trouble free service if you follow the installation instructions below, which are offered as a general guide.

Please read the instructions fully before starting assembly.

Important Safety Notes:

The Curve shelters are designed as an open garden shelter which can be used as rest area or dining area but not for barbecue or any other activities involving fire and smoke. Please take this into account if you intend to use the shelter for some other purpose.

The Curve shelters design allows for some protection from showers and the wind, but should not be expected to be fully waterproof.

The structure needs to be fixed into the ground using the steel brackets (in the case of the Curve) or steel brackets and posts supplied (in case of the Demi Curve), each of which needs to be dug in and concreted at least 600mm, in order for the structure to be strong & stable. It is not sufficient to fix onto a surface just with metal shoes or feet. Take extra care in windy conditions as the panels may catch the wind and cause an injury.

Please do not allow anyone to climb on the structure. There are safety risks related to people trying to climb on these structures – they are over 2m tall and not designed for climbing on.

Any significant snow build up on the curve should be cleared off with a soft brush, to reduce the weight on the structure and hence the risk of distortion, or in extreme situations the risk of collapse.

Do not tighten the polycarbonate sheet fixings as they are kept slightly loose to allow sheets to expand and shrink.

Delivery restriction:

Our lorry driver will only be able to unload the curves onto a hard standing very near the road, using the lorry-mounted fork truck.

For The Curve, the delivered pack of 4 curves measure approximately 3.6m wide (i.e. across the forks) x 1.60m deep (along the forks) x 1.60m tall, and weighs around 400kg including packaging.

For The Demi Curve, the delivered pack of 2 curves measure approximately 3.6m wide (i.e. across the forks) x 1.60m deep (along the forks) x 1.60m tall, and weighs around 220kg including packaging.

As the curve panels are heavy (approx. 90Kg each), take extra care when unpacking to avoid any risk of injuries or product damage.

Please confirm that there is a suitable space which the fork truck can easily maneuver into with the pack. If in doubt please call our Transport team. If we are unable to deliver successfully we may have to abort and plan for re-delivery by other means, with associated additional delivery charges.

An access route with a minimum width of 900mm is required, from the point of delivery to the place where the Curve products are required to be installed. As The Curve panels are heavy (approx. 90Kg each), 3-4 persons are normally required to manually handle them, possibly using a low trolley, skate, or slings

Jacksons Fencing Head Office
Stowting Common
Ashford Kent TN25 6BN
Tel +44(0)1233 750 393
www.jacksons-fencing.co.uk

Fax +44(0)1233 750 403
info@jacksons-fencing.co.uk

Jacksons
Guaranteed Quality since 1947
www.jacksons-fencing.co.uk

Specific Tools required, in addition to the materials supplied by Jacksons:

Spirit level, 8m tape measure, cordless drill, small sledge hammer

2 no. temporary support post approx 2m long, e.g. 100mm x 50mm (1 No required for Demi Curve),

4 no. temporary wooden pegs approx. 0.4m long, e.g. 50mm x 50mm (Not required for Demi Curve),

Step ladder suitable to work at 2.2m height

For Installation instructions for "The Curve" go to page 3 or for installation instructions for "The Demi Curve" go to page 11.

- Continued-

Jacksons Fencing Head Office
Stowting Common
Ashford Kent TN25 6BN
Tel +44(0)1233 750 393 Fax +44(0)1233 750 403
www.jacksons-fencing.co.uk info@jacksons-fencing.co.uk

Jacksons
Guaranteed Quality since 1947
www.jacksons-fencing.co.uk

Installation Process for the CURVE:

Step 1: Check that all the assembly parts are provided as shown below.

Item description and approx. dimensions	Stock Code	Qty
Curve Panels (3.5m Length x 1.55m Width) – Curved Length 3.8m	655801	4
Curve Cover Strip 1.6m x 50mm x 10mm	655802	2
Top Bracket 0.5m x 90mm x 6mm Stainless steel (both end rounded)	655803	2
Centre Bracket 0.5m x 90mm x 6mm Stainless steel (one end rounded)	655804	2
Bottom Bracket 0.8m x 50mm x 6mm Stainless steel (one end rounded)	655805	4
Post Cap		1
M6 x 50mm CSK Screws S/S		28
M5 x 95mm Play Fence Screws S/S		16
M5 x 45mm CSK Screws S/S		12
M5 x 90mm CSK Screws S/S		2
M4 x 40mm CSK Screws S/S		12
Felt Nails		10
Foam 3.3m x 75mm W x 6mm THK, for ridge join		1
M6 x 50mm Bolts		6
M6 Nuts		6

Depending on the ground conditions, the installation requires around 10 bags of post mix (Stock Code 648070) for base bracket holes, which can be ordered separately.

Step 2: Make sure that the surface on which the Curve is to be installed is stable and flat. Overall dimensions for the Curve are 3.15m Wide x 5.43m Deep x approx 2.23m High. It is recommended to leave 900mm clear space around the Curve for installation and cleaning during use (e.g. Snow Clearance).

Step 3: Mark the positions for the centre and bottom brackets and dig holes 450mm deep x (250mm x 250mm square) as shown below in Figure 1. Also drive into the ground the 4 no's temporary wooden pegs at the positions shown, in between these holes, using the sledge hammer.

Jacksons Fencing Head Office
Stowting Common
Ashford Kent TN25 6BN
Tel +44(0)1233 750 393 Fax +44(0)1233 750 403
www.jacksons-fencing.co.uk info@jacksons-fencing.co.uk

Jacksons
Guaranteed Quality since 1947
www.jacksons-fencing.co.uk

Figure 1: Plan View

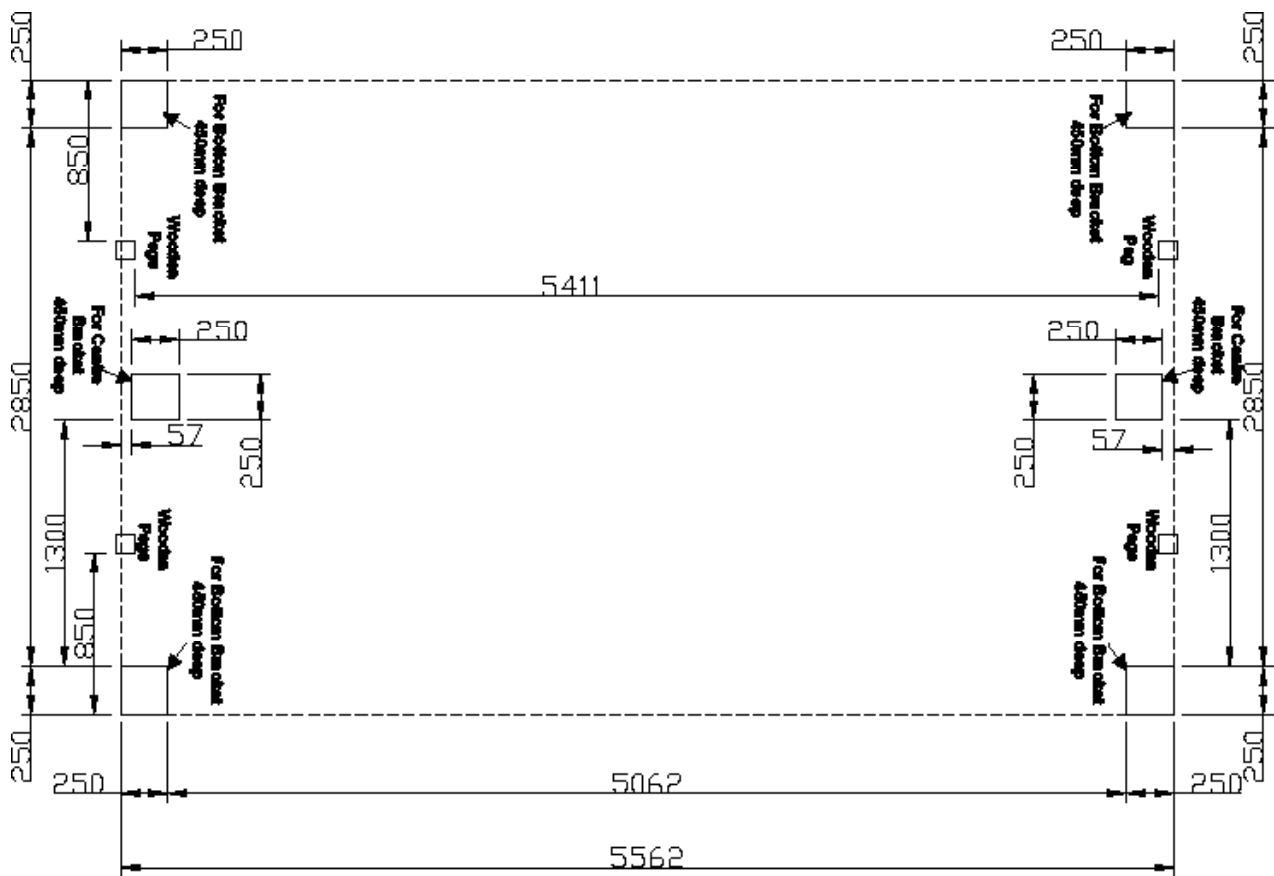

Step 4: Each curve panel is labelled on the side which needs to go up. Erect one of the curve panels with the help of temporary support posts and supported by the wooden peg at the bottom end as shown below in Figure 2a & 2b. It is advisable to temporarily fix the support post to The Curve with a clamp or a screw. Take extra care in windy conditions as the panels may catch the wind and cause an injury. Position the screw so that when removed the hole left will not be unsightly. Adjust The Curve panel to match the key dimensions shown in Figure 2b. Attach the Foam provided to the face of The Curve using nails provided as shown in Figure 2b. Make sure the foam is attached to the top end of the face. Do not cut the Foam at the end as it is required to be attached to the face of the adjacent Curve panel later.

Jacksons Fencing Head Office
 Stowting Common
 Ashford Kent TN25 6BN
 Tel +44(0)1233 750 393
 www.jacksons-fencing.co.uk

Fax +44(0)1233 750 403
 info@jacksons-fencing.co.uk

Jacksons
 Guaranteed Quality since 1947
www.jacksons-fencing.co.uk

Figure 2a: Plan View

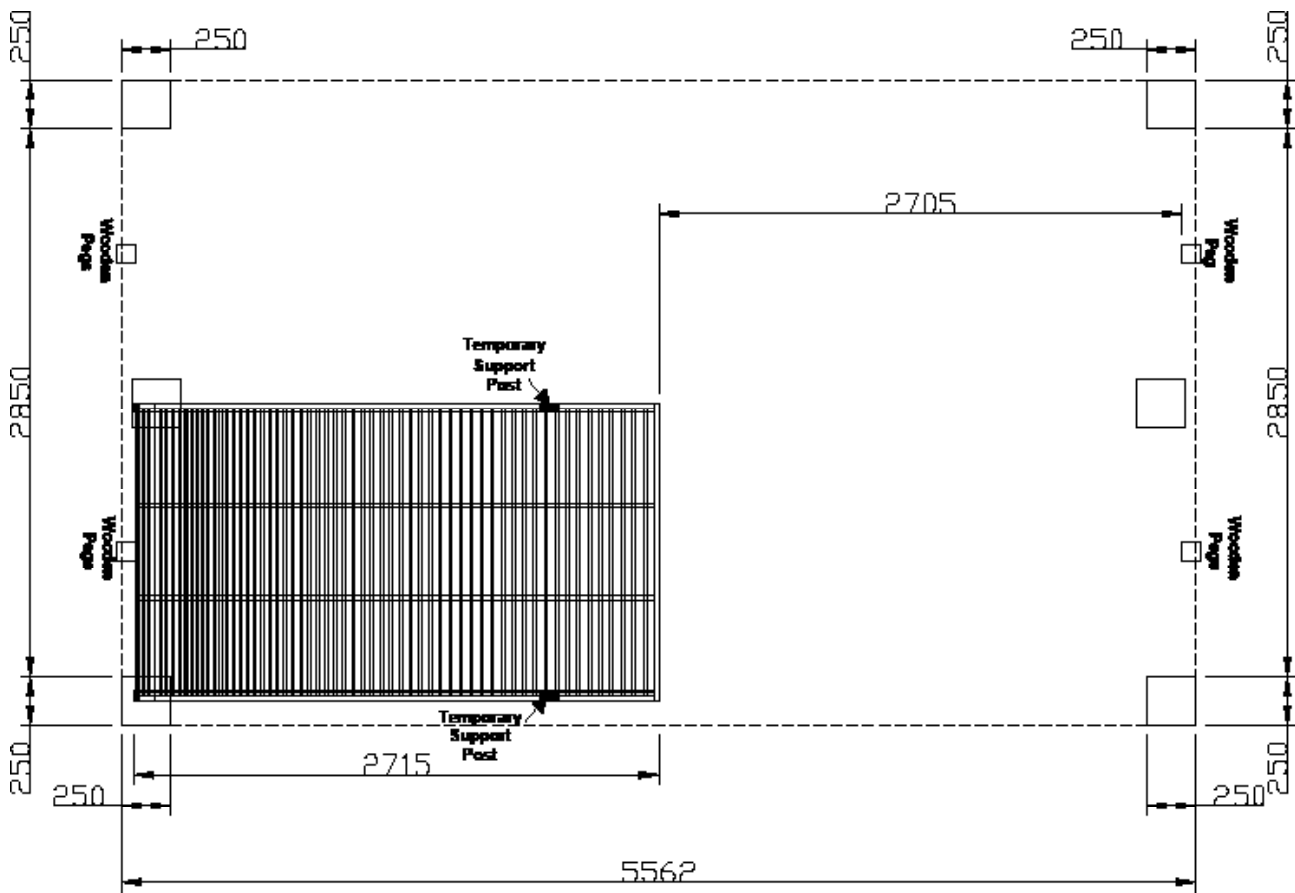
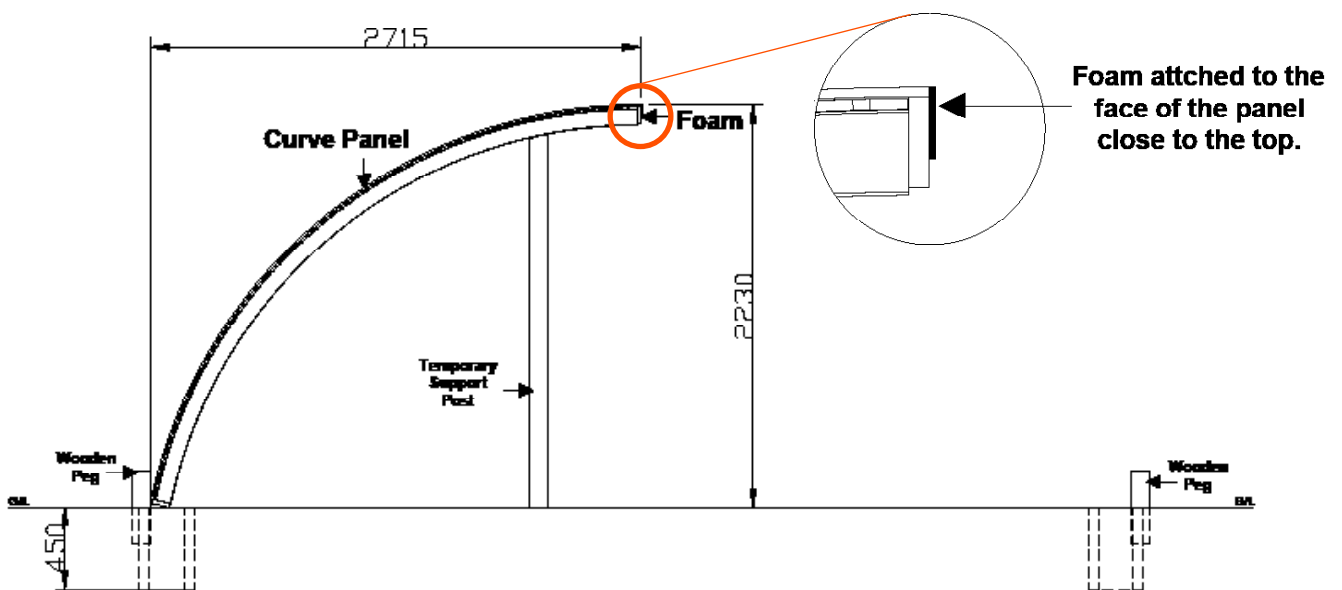

Figure 2b: Top View



Jacksons Fencing Head Office
 Stowting Common
 Ashford Kent TN25 6BN
 Tel +44(0)1233 750 393
 www.jacksons-fencing.co.uk

Fax +44(0)1233 750 403
 info@jacksons-fencing.co.uk

Jacksons
 Guaranteed Quality since 1947
 www.jacksons-fencing.co.uk

Step 5: Erect the second Curve panel opposite the first panel so that their faces align with each other and foam attached to the face of the first panel is sandwiched between them as shown in Fig 4a & 4b. Check for the key dimensions as shown in Figure 4b and also check that the line of the curve runs smoothly from one Curve panel to the other. Attach the two Curve panels together using M5 x 45mm CSK Screws S/S – 6 no screws at equal spacing and from alternate sides through the Curve end frames and the foam.

Figure 4a: Plan View

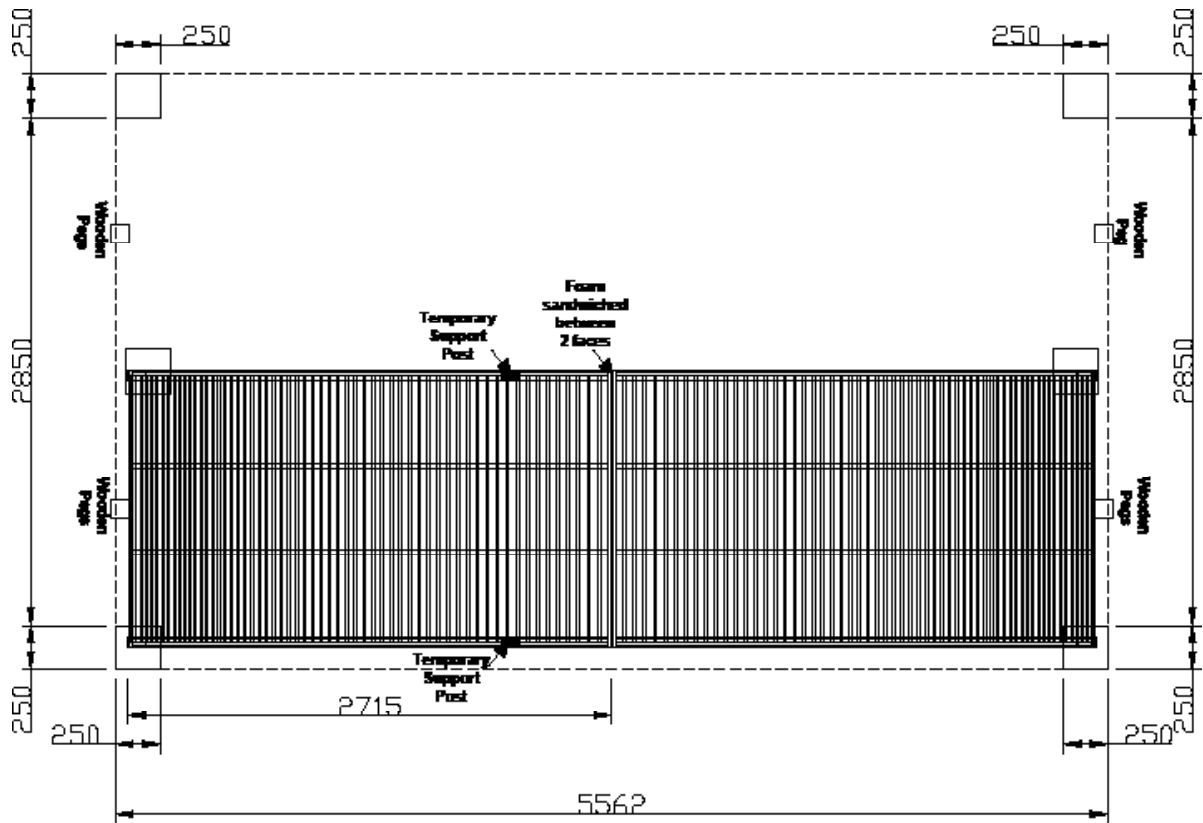
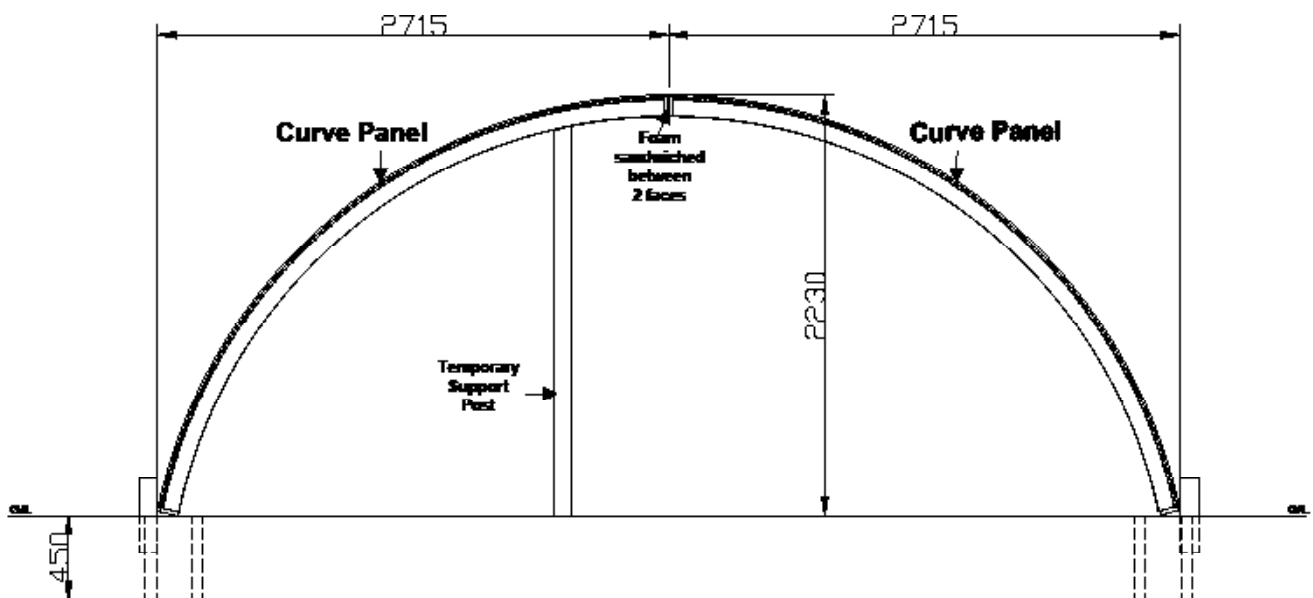

Figure 4b: Front View



Jacksons Fencing Head Office
 Stowting Common
 Ashford Kent TN25 6BN
 Tel +44(0)1233 750 393
 www.jacksons-fencing.co.uk

Fax +44(0)1233 750 403
 info@jacksons-fencing.co.uk

Jacksons
 Guaranteed Quality since 1947
www.jacksons-fencing.co.uk

Step 6: Erect the third Curve panel adjacent to one of the panels using the temporary support posts and supported by the wooden peg at the bottom end as shown in Figure 5. Align the Curve panel to the adjacent panel so that they are squarely face to face and attach them together using M5 x 95mm CSK Screws S/S - 8 no screws at equal spacing and from alternate sides. It is advisable to pre-drill the holes for these to minimize the risk of splitting. Attach the foam to the front face of this panel using nails provided.

Figure 5: Plan View

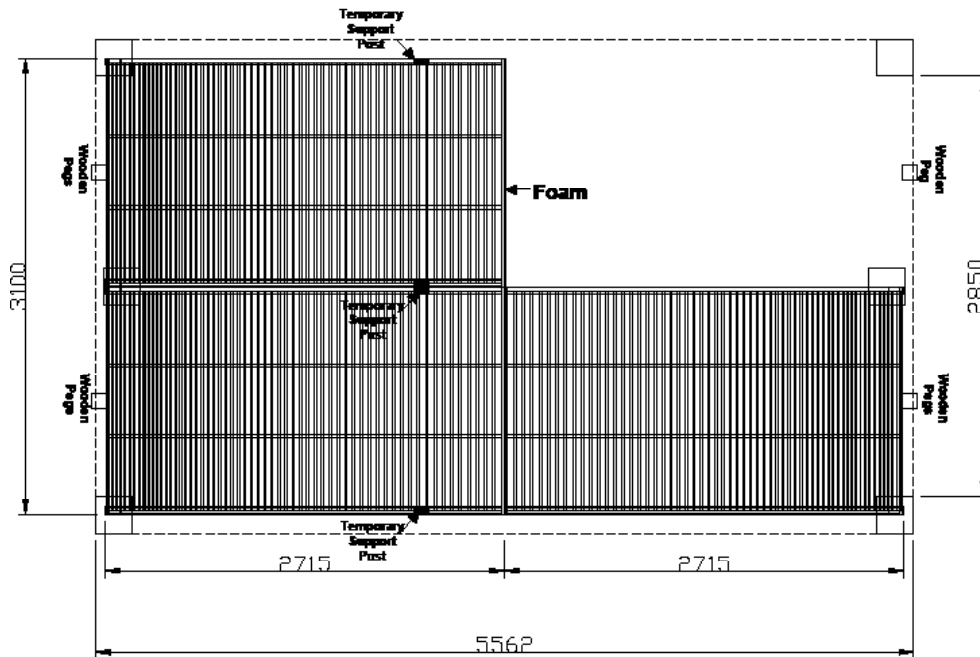

Step 7: Erect the last Curve panel opposite to the third panel following Step 5 & 6 as shown in Figure 6.

Figure 6: Plan View

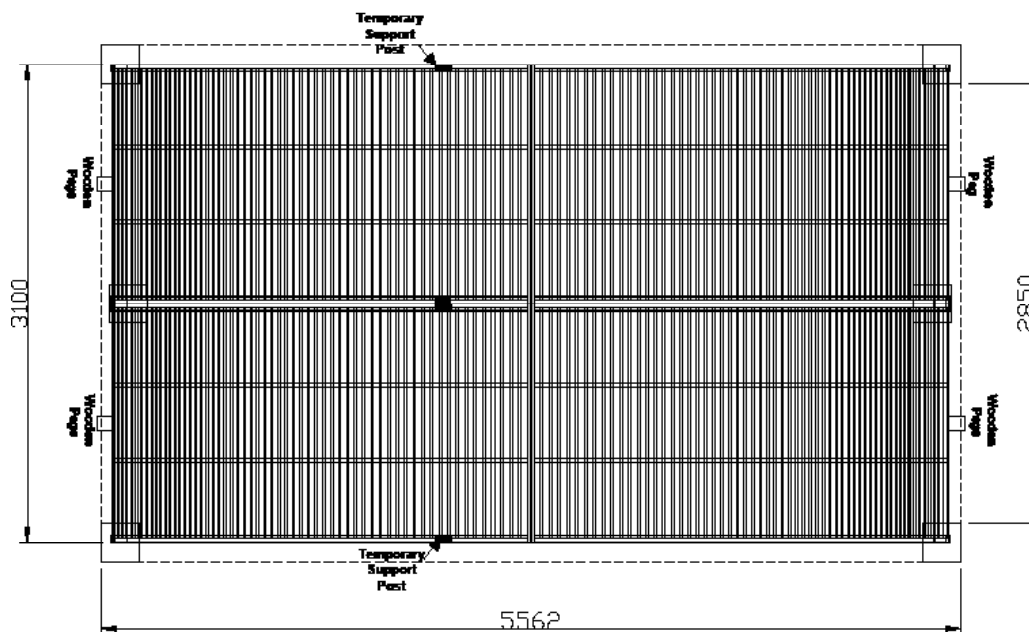

Jacksons Fencing Head Office
 Stowting Common
 Ashford Kent TN25 6BN
 Tel +44(0)1233 750 393 Fax +44(0)1233 750 403
 www.jacksons-fencing.co.uk info@jacksons-fencing.co.uk

Jacksons
 Guaranteed Quality since 1947
www.jacksons-fencing.co.uk

Step 8: Fix the top brackets at the outer top end of joining curved panels using M6 x 50mm CSK screws. Attach the 50mm x 6mm stainless steel bottom brackets on the outer end of each curve panel sides using M6 x 50mm CSK screws. Position the bottom bracket such that minimum of 300mm of the bracket will go into the ground. Next fix the 90mm x 6mm centre brackets to the inside face of the joining curved panels frame at the bottom using M6 x 50mm CSK screws. Position the bottom bracket such that minimum of 240mm of the bracket will go into the ground. It is recommended to drill pilot holes for the brackets before (Reference Figure 7a & 7b).

Figure 7a: Front View

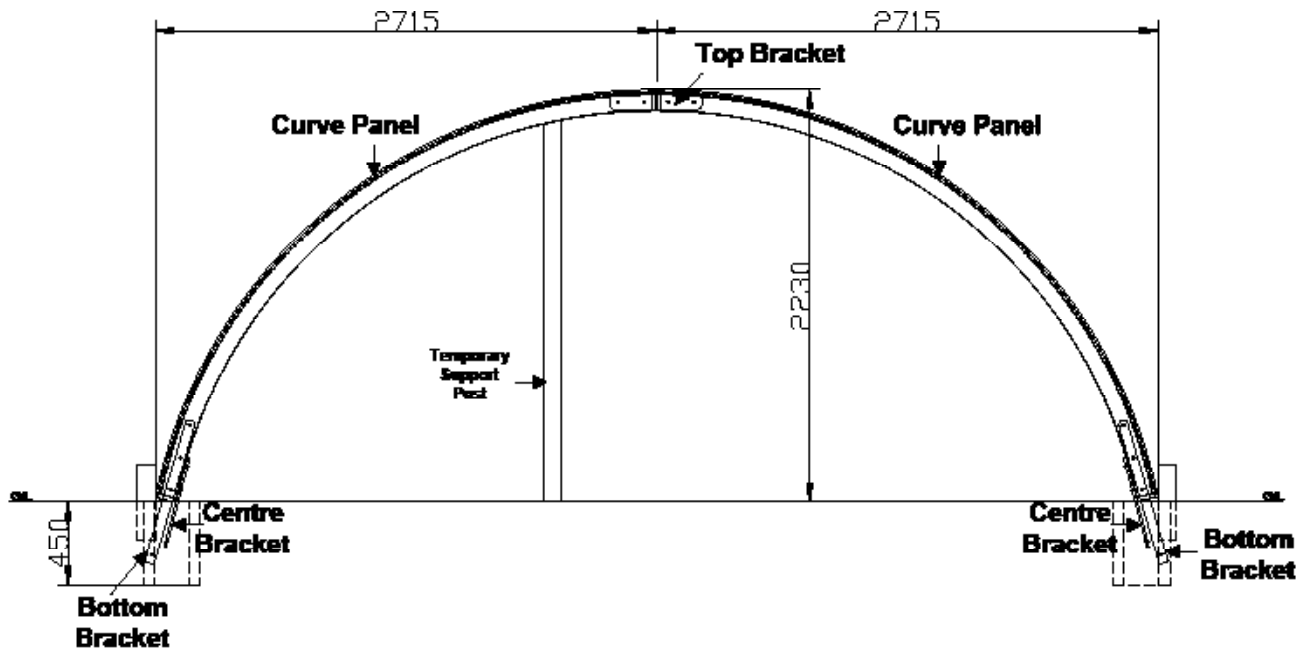
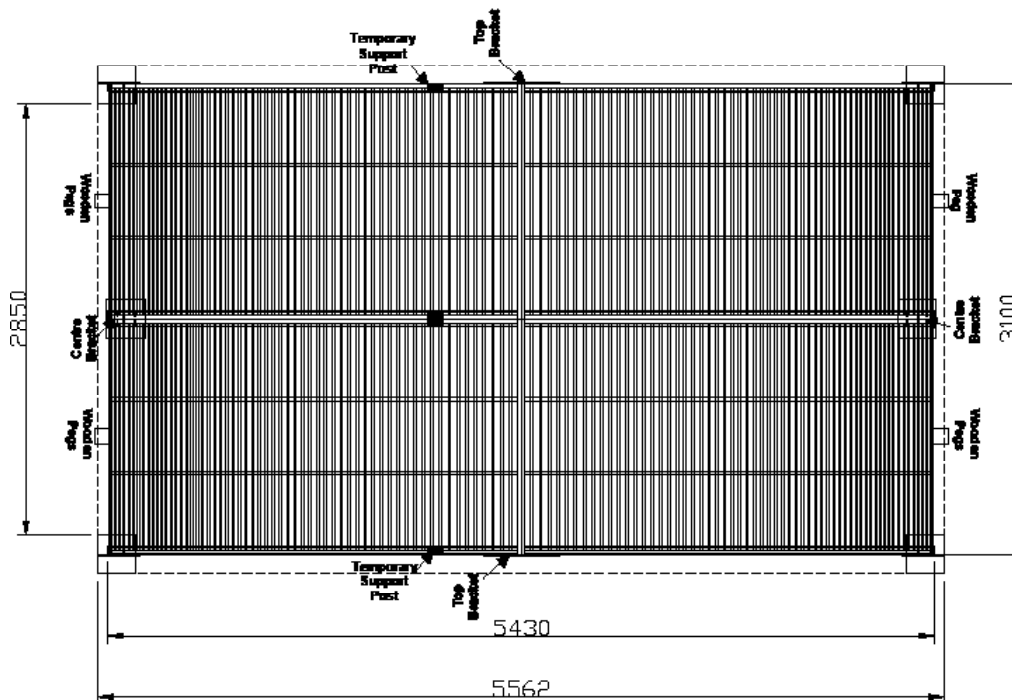

Figure 7b: Plan View



Jacksons Fencing Head Office
 Stowting Common
 Ashford Kent TN25 6BN
 Tel +44(0)1233 750 393
 www.jacksons-fencing.co.uk

Fax +44(0)1233 750 403
 info@jacksons-fencing.co.uk

Jacksons
 Guaranteed Quality since 1947
www.jacksons-fencing.co.uk

Step 9: It is important to note that each of bottom and centre bracket's have 1 hole in the lower part going into the concrete. Fix M6 x 50mm bolts with nuts in these holes as these will help in securing the brackets to the concrete when added. Check all the key dimensions as shown in figure 7a & 7b before filling the base holes with concrete, taking care not to splash concrete onto the above-ground items.

Figure 8: Front View

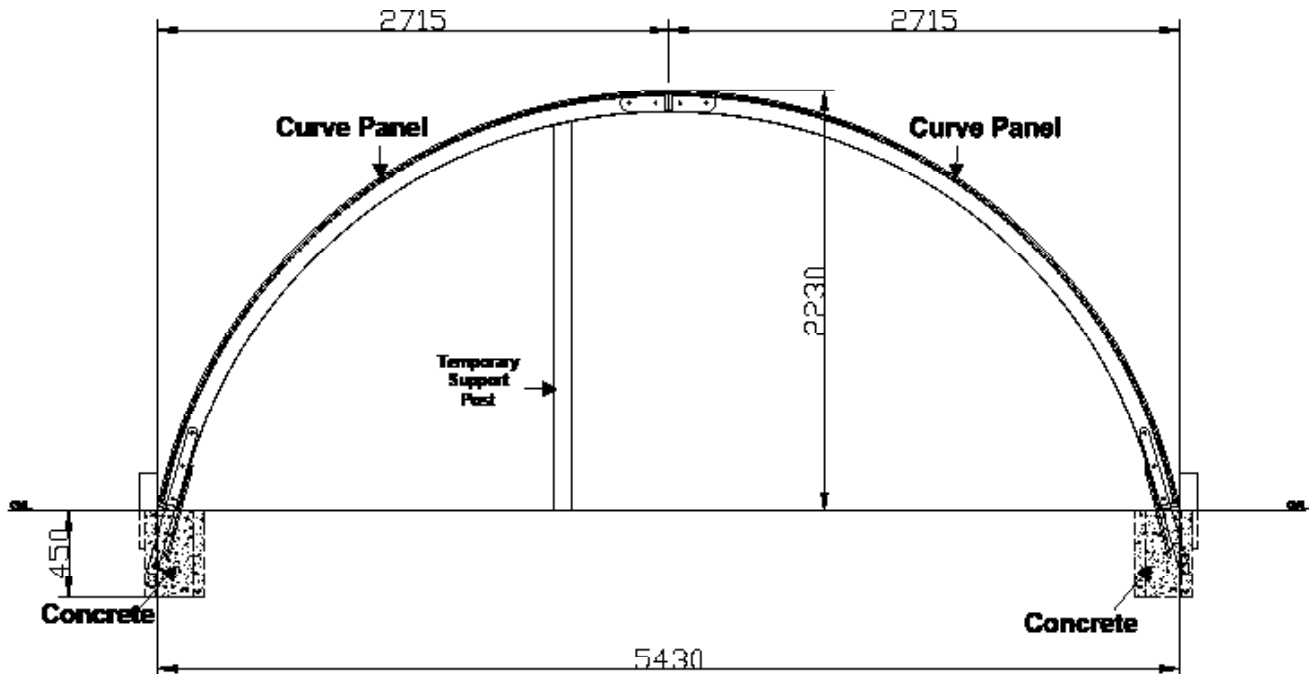

Step 10: Once concrete has set, remove all the temporary posts and wooden pegs. Install the post cap under the centre of The Curve where all the panels join together using 2 no M5 x 95mm CSK screws S/S. Then install the cover strips along the joining faces of The Curve panels on both sides of the post cap using M4 x 40mm CSK screws S/S to complete the installation as shown in figure 9a & 9b.

Figure 9a: Front View

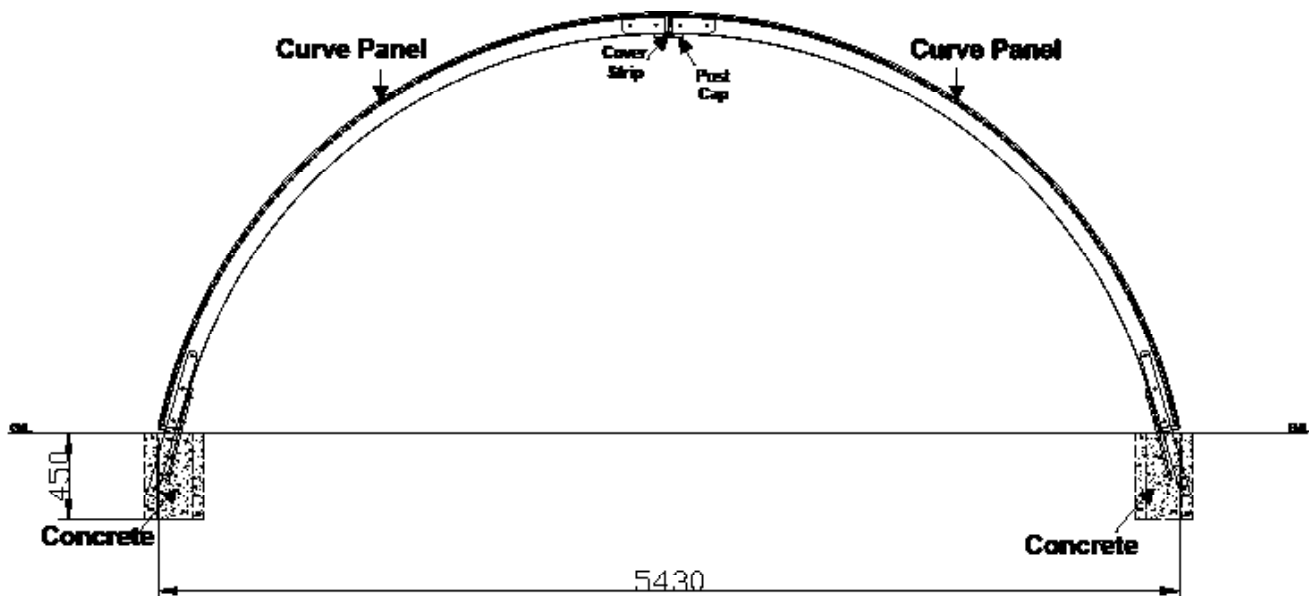

Jacksons Fencing Head Office
 Stowting Common
 Ashford Kent TN25 6BN
 Tel +44(0)1233 750 393 Fax +44(0)1233 750 403
 www.jacksons-fencing.co.uk info@jacksons-fencing.co.uk

Jacksons
 Guaranteed Quality since 1947
www.jacksons-fencing.co.uk

Figure 9b: Plan View

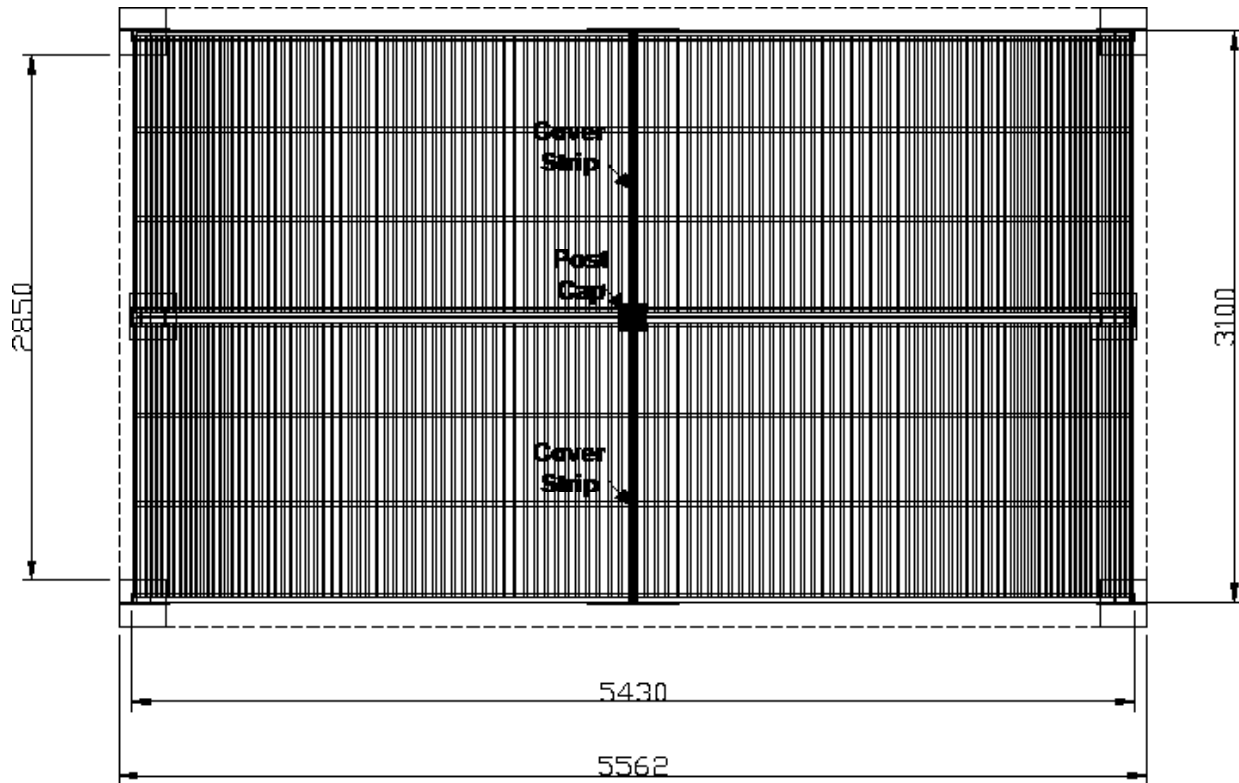

Jacksons Fencing Head Office
Stowting Common
Ashford Kent TN25 6BN
Tel +44(0)1233 750 393
www.jacksons-fencing.co.uk

Fax +44(0)1233 750 403
info@jacksons-fencing.co.uk

Jacksons
Guaranteed Quality since 1947
www.jacksons-fencing.co.uk

Installation Process for the DEMI CURVE:

Step 1: Check that all the assembly parts are provided as shown below.

Item description and approx. dimensions	Stock Code	Qty
Curve Panels (3.5m Length x 1.55m Width) – Curved Length 3.8m	655801	2
Centre Bracket 0.5m x 90mm x 6mm Stainless steel (one end rounded)	655804	1
Bottom Bracket 0.8m x 50mm x 6mm Stainless steel (one end rounded)	655805	2
Cover Board 3.1m x 145mm x 34mm	655882	1
Slotted Post 2.7m x 95mm x 95mm	655881	2
M6 x 50mm CSK Screws S/S		10
M5 x 95mm Play Fence Screws S/S		14
M5 x 45mm CSK Screws S/S		6
60mm Deck Screws		8
M6 x 50mm Bolts		3
M6 Nuts		3

Depending on the ground conditions, the installation also requires around 11 bags of post mix (Stock Code 648070), and a small amount of gravel or ballast (code 648110) for post hole bases, which can be ordered separately.

Step 2: Make sure that the surface on which the Demi Curve is to be installed is stable and flat. Overall dimensions for the Demi Curve are 3.15m Wide x 2.75m Deep x approx 2.2m High. It is recommended to leave at least 900mm clear space at the back end for installation and cleaning if required during the use (e.g. Snow Clearance).

Step 3: Mark the positions for the posts, centre and bottom brackets and dig holes 550-600mm deep x (300mm x 300mm section) for posts and 450mm deep x (250mm x 250mm section) for brackets as shown below in Figure 1.

Figure 1: Top View

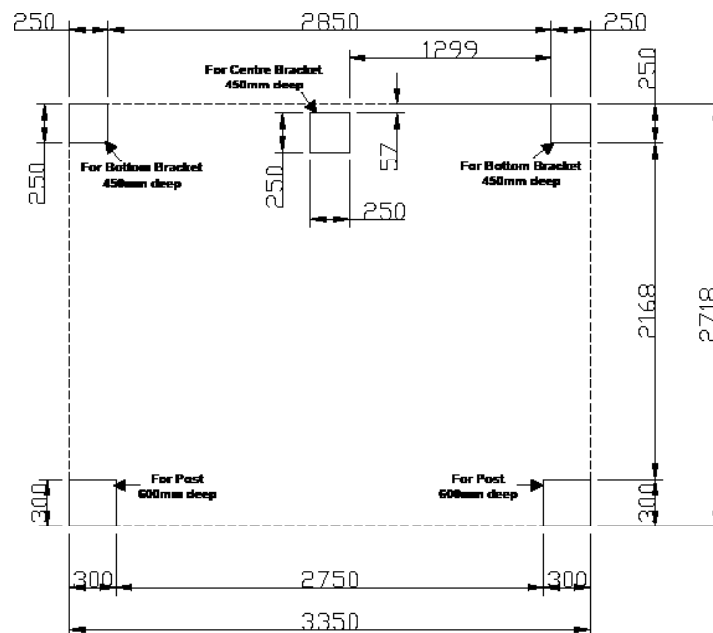

Jacksons Fencing Head Office
 Stowting Common
 Ashford Kent TN25 6BN
 Tel +44(0)1233 750 393
 www.jacksons-fencing.co.uk

Fax +44(0)1233 750 403
 info@jacksons-fencing.co.uk

Jacksons
 Guaranteed Quality since 1947
www.jacksons-fencing.co.uk

Step 4: Install the posts, referring to our Installation Instruction JFW28 Timber Fence Post (available on our website, www.jacksons-fencing.co.uk), with spacing as shown below in Figure 2a & 2b

Figure 2a: Front View

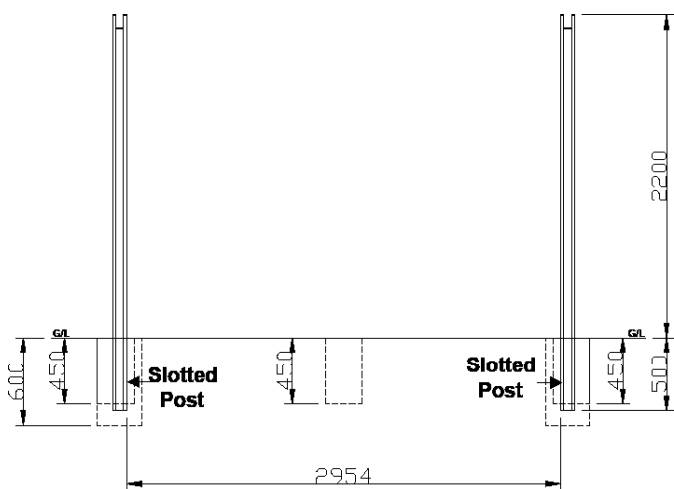
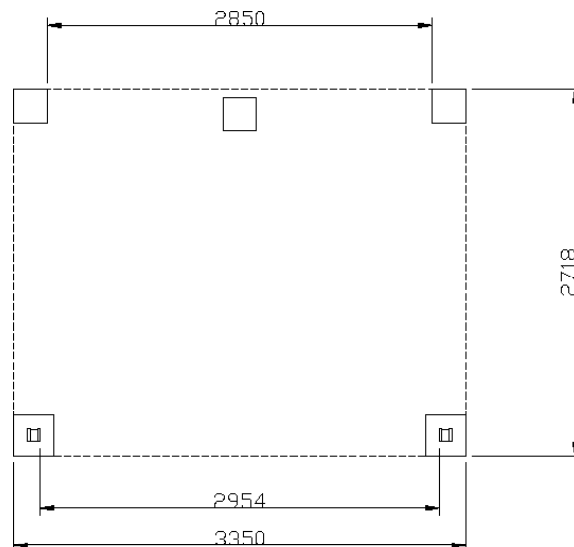
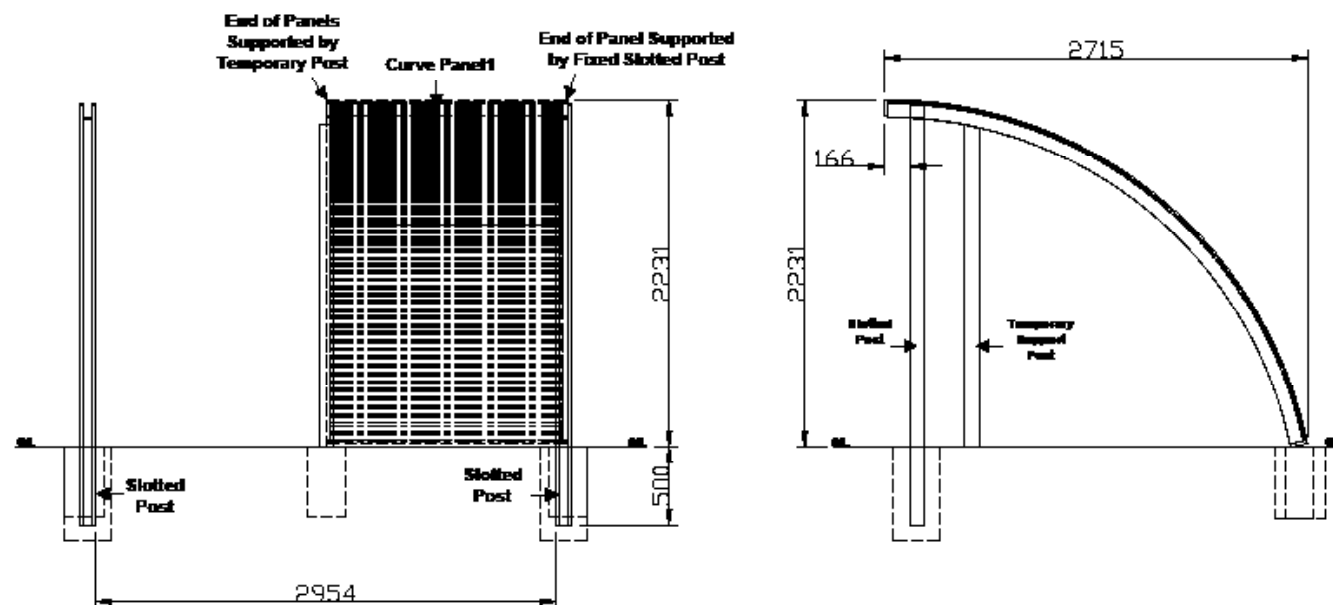

Figure 2b: Top View



Step 5: Slot one side of one panel curve into one of the posts and support the other side using a temporary support post on the other curve, as shown in Figure 3. Leave part of the top of this post exposed so the curve of the second panel can also be propped on it. To help keep the temporary post in place, you can temporarily use a 60mm or 95mm screw to secure it to the curve, ensuring any hole made in the curve is as inconspicuous as possible. Align the curve panels so that the front end of the curves are square and have an overhang of approx. 166mm on the front side.

Figure 3



Jacksons Fencing Head Office
 Stowting Common
 Ashford Kent TN25 6BN
 Tel +44(0)1233 750 393 Fax +44(0)1233 750 403
www.jacksons-fencing.co.uk info@jacksons-fencing.co.uk

Jacksons
 Guaranteed Quality since 1947
www.jacksons-fencing.co.uk

Step 6: Erect the second panel in the same way as stated in step 5. Align the two curve panels so that the front end of the curves are square and have an overhang of approx. 166mm on the front side as shown in Figure 4. Join the two curves in the centre using M5 x 95mm screws 4 no's from each side, equally spaced and at alternate positions.

Figure 4

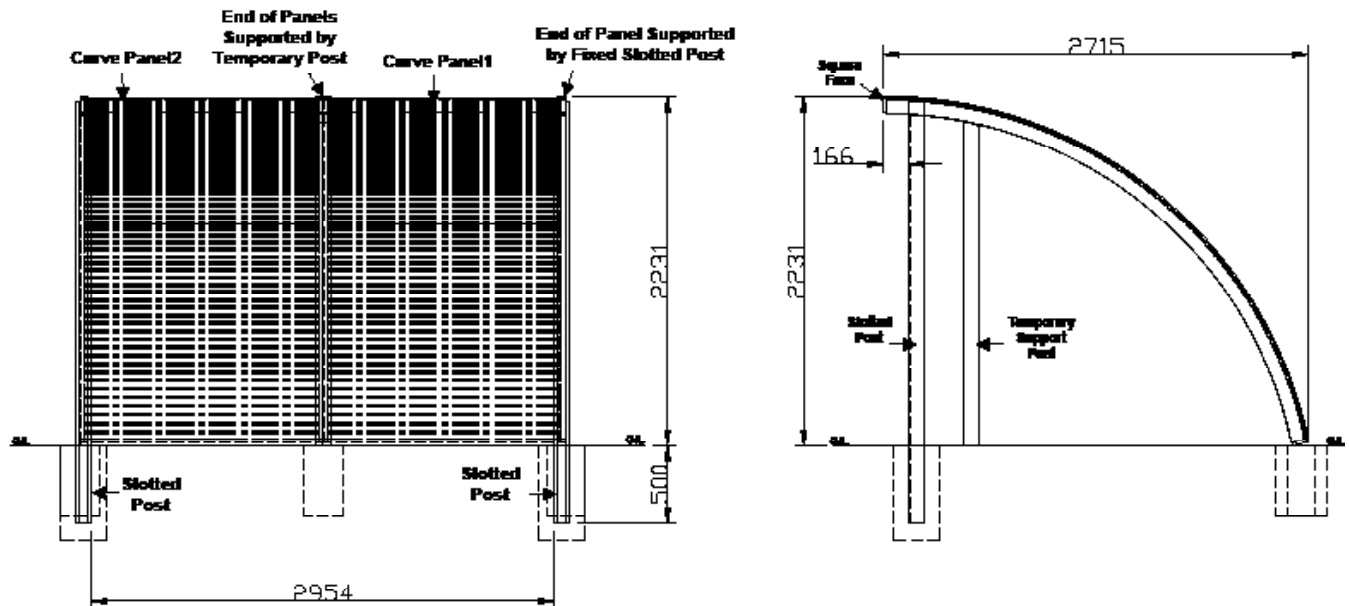

Step 7: Fix the front cover board to the square end of the curve panels using M5 x 95mm screws at positions where the cover board faces the end of the panel frame (2 no's at each position) and M5 x 45 mm CSK screws in between. Also attach the bottom brackets on each end of the curve panel sides using M6 x 50mm CSK screws. Position the bottom bracket such that minimum of 300mm of the bracket will go into the ground. Next fix the centre bracket to the inside face of the joining curved panel frame at the bottom using M6 x 50mm CSK screws. Position the bottom bracket such that minimum of 240mm of the bracket will go into the ground. It is recommended to drill pilot holes for the brackets before. (Reference Figure 5).

Figure 5: Side View

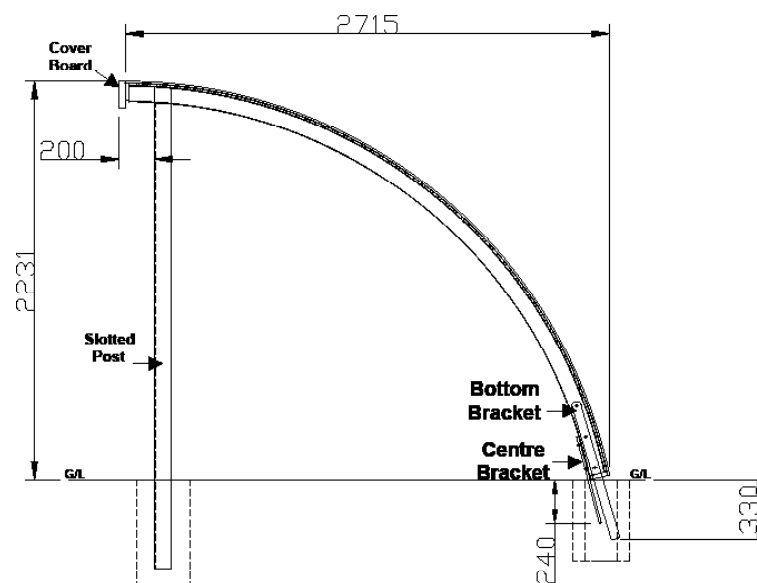

Jacksons Fencing Head Office
 Stowting Common
 Ashford Kent TN25 6BN
 Tel +44(0)1233 750 393
 www.jacksons-fencing.co.uk

Fax +44(0)1233 750 403
 info@jacksons-fencing.co.uk

Jacksons
 Guaranteed Quality since 1947
www.jacksons-fencing.co.uk

Step 8: It is important to note that each of bottom and centre bracket's have 1 hole in the lower part going into the concrete. Fix M6 x 50mm bolts with nuts in these holes as these will help in securing the brackets to the concrete when added. Check all the key dimensions as shown in figure 5 before filling the base holes with concrete, taking care not to splash concrete onto the above-ground items as this is very difficult to remove. Once concrete has set, remove the temporary posts to complete the installation.

Maintenance Requirements:

Do not tighten the polycarbonate sheet fixings as they are kept slightly loose to allow sheets to expand and shrink.

Periodically inspect the structure for any signs of damage.

Clear off snow in extreme conditions

The polycarbonate sheeting can be washed off with a sponge and plenty of soapy water. Be aware that polycarbonate sheeting can scratch easily, so do not allow the sponge to dry out during washing and avoid abrasives and harsh chemicals.

Keep the areas around the bases of The Curve free from undergrowth and debris. Avoid strimming up against the surfaces as this can easily damage the timber and sheeting.

-End-

Treated Timber Safety Note:

Biocidal Products Regulation (EU528/2012):

Jakcured articles incorporate biocidal products to protect against wood destroying organisms.

Active ingredients include: Copper(II)Carbonate / Copper(II)Hydroxide / Propiconazole / AQAAA

Wear gloves when handling freshly treated wood. Avoid breathing dust when cutting.

Dispose of off-cuts responsibly – do not burn.

Jacksons Fencing Head Office
Stowting Common
Ashford Kent TN25 6BN
Tel +44(0)1233 750 393
www.jacksons-fencing.co.uk

Fax +44(0)1233 750 403
info@jacksons-fencing.co.uk

Jacksons
Guaranteed Quality since 1947
www.jacksons-fencing.co.uk